



STM  Scale
Through
Modularity

www.nexo.fr

NEXO





STM M28 Omni-purpose Module

STM M46 Main Module

The building blocks
for every system you'll ever need.



NEXO



STM B112 Bass Module

STM S118 Sub Module

For too long now, the business of a sound rental company has been dictated by system manufacturers. You need one type of system to be in the touring market, another for corporate jobs, and so on. It all adds up to a lot of boxes that often spend more time in the warehouse than they do on the road.

STM changes all that. The concept of Scale Through Modularity delivers a new level of versatility, enabling contractors to design a wide range of systems from just four compact, powerful and proportionally-sized modules. And in applications large and small, these systems can significantly outperform existing solutions.

Of course increased versatility brings a welcome improvement in return on investment. But with STM, that's just the start. From system storage and configuration, through transportation and rigging, to wiring and amplification, STM delivers important operational and logistical cost savings at every stage of the process.

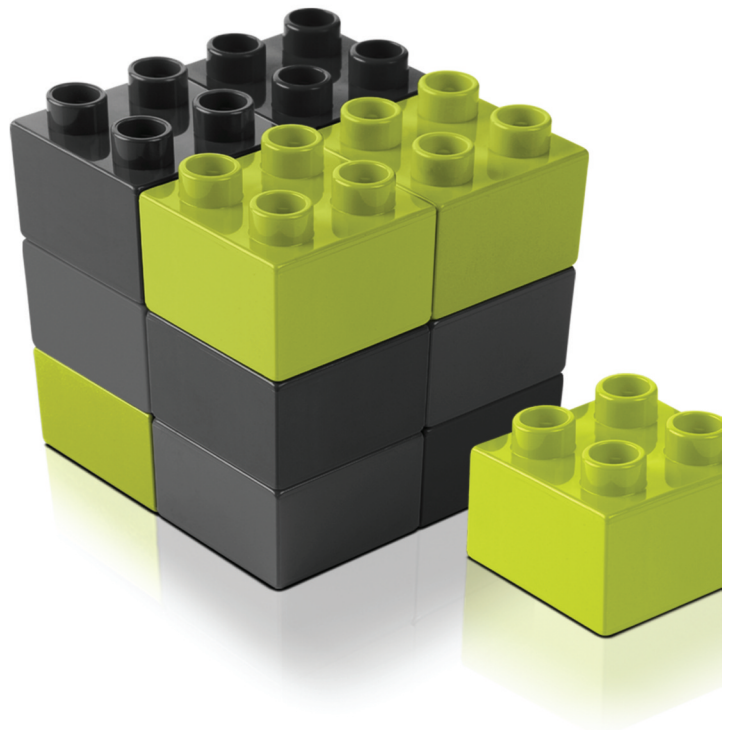



Groundstack

A simple groundstack is perfect for small applications.

M28 single column

A single column of M28 Omni modules creates a powerful, compact and lightweight system, perfect for speech and small venue music applications.

From a simple groundstack
to a compact, powerful array.



NEXO



M28 with added bass

For rock music in larger venues, flying B112 Bass modules above M28s increases headroom and LF response.



M46 single column with M28 downfills

M28 Omni modules operate as downfills on a single column of M46 Main modules.



Double column

In large format applications, a double column of M46 Main and B112 Bass modules flown on a lightweight bumper is smaller and more powerful than competitive line arrays.

From a simple groundstack to a compact, powerful line array, STM makes it quick and easy to 'clip together' the systems you need for any job.

Configuration possibilities include M28 Omni or M46 Main cabinets only, Omni/Main + Bass, Omni/Main + Sub, Omni/Main + Bass + Sub, any of which can be supplemented by the M28 Omni module operating as a downfill. The wide operating frequency range of the M28 Omni cabinets means that many speech or light music events can be run effectively with M28 alone, thereby removing the need for any extra cabinets. If programme material calls for low frequency extension, the 25-120Hz range of the S118 sub and the 55-200Hz range of the B112 bass offer the user complete freedom when configuring the system to achieve the desired frequency response or power.





Double column with downfills

The lightweight bumper includes adjustment to enable a straight hang where M28 Omni modules are used as downfills on one column only.

NEXO

The perfect system for every event.

STM is all about flexibility, so there's no such thing as a 'typical system'. Operators use NS-1 configuration software (see page 15) to design the perfect system for the application at hand. STM's modular approach means there's no longer a requirement to own separate small, medium and large systems as applications of any size and scale can now be handled from a common inventory of STM modules.

Sharing the same footprint as the other STM modules, and precisely twice the height of the Main and Bass cabinets, the STM S118 Sub-Bass module also shares the same rigging system, allowing it to be groundstacked or flown above, below or between other STM modules. Using a single 18" driver in an innovative cabinet design, the S118 delivers performance levels comparable to NEXO's acclaimed CD18 2 x 18" sub, empowering the STM system with a compact, potent and highly musical sub-bass solution. The STM Sub can be used in omni or cardioid modes depending on cabinet positioning and preset selection.





Pushing the envelope.

Problem-solving possibilities beyond the norm.

True modularity makes it possible to configure an STM system for every application – systems that are often more compact than conventional line arrays.

But STM isn't just about convenience, efficiency and return on investment. It's also about performance. The facility to configure large scale systems from four compatible modules can deliver a dream system for rock and metal bands, with unprecedented low frequency headroom.





NEXO

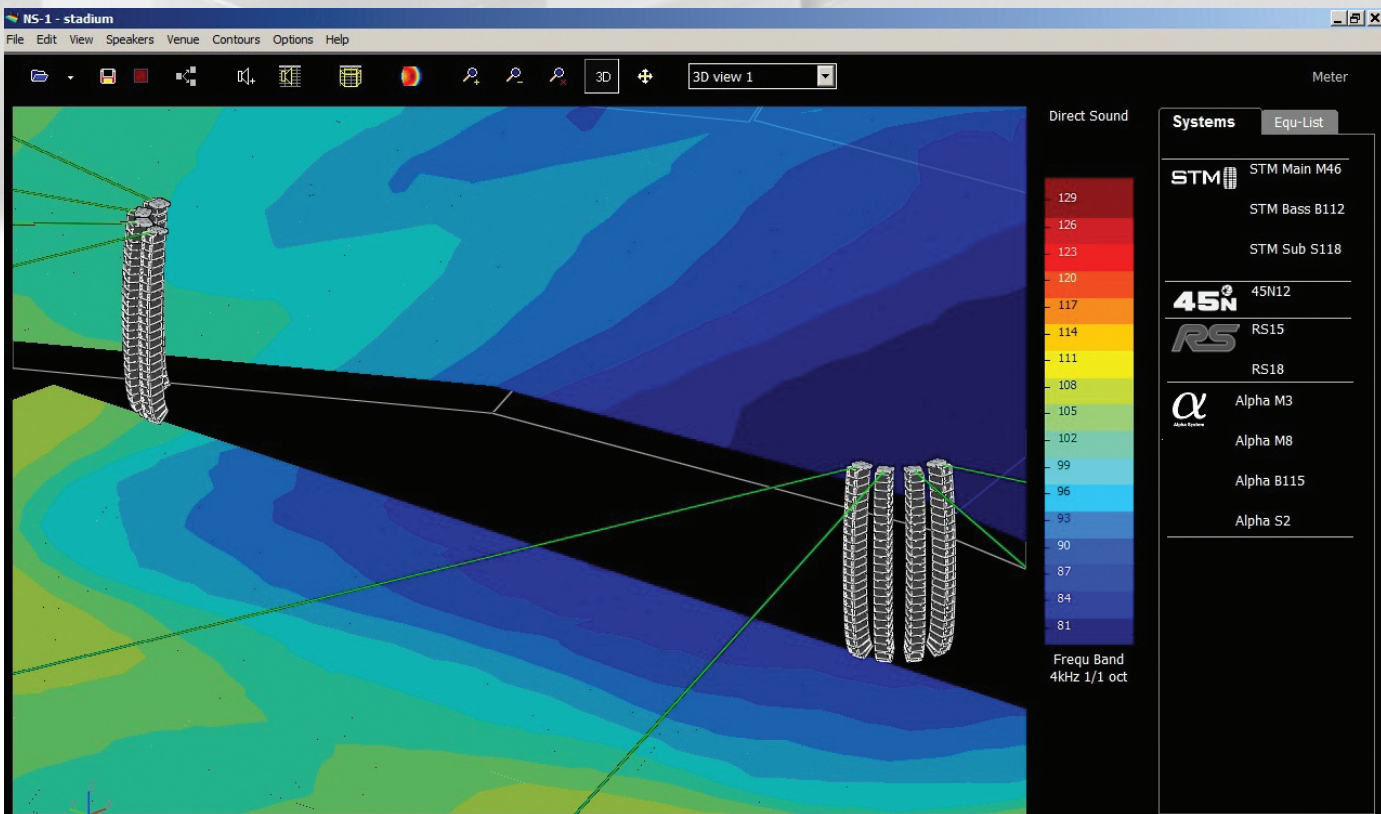

STM Large-Format System

Configured using NS-1 system simulation tool.

STM modularity offers unique solutions to common audio problems. For example, in arena, stadium or large festival applications, the well-known issue of low-frequency interference between main and side hangs can be addressed by centralising the B112 Bass cabinets in separate hangs between forward and outward facing M46 Main cabinet arrays, thereby ensuring the bass frequencies emanate from a single source.

The concept of true modularity is equally welcome in small venues, where STM's Omni/Main cabinets can be flown alone and Bass and/or Sub cabinets can be groundstacked to overcome the limitations of low weight-bearing facilities (for example, 500kg points).



Sound science.

Increased performance through better design.

Throughout its 30 year history, NEXO has earned a reputation for innovation, developing patented technologies that have advanced the science of sound reinforcement.

STM continues this tradition with the application of a number of new technologies in the areas of midrange and high-frequency reproduction, and low frequency control.

Symmetrical architecture

M28 Omni and M46 Main modules employ 2 x 8" and 4 x 6.5" long excursion drivers respectively in a symmetrical configuration. HF drivers use Keytone Polymer diaphragms to eliminate distortion up to 18kHz.

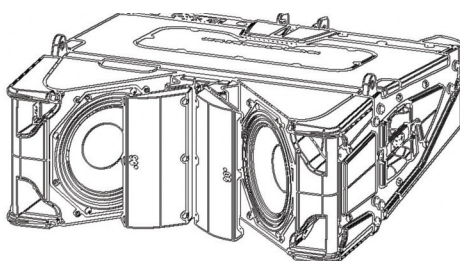

STM M28 Omni Module.

Flat membrane MF drivers for uninterrupted HF expansion

The use of flat membrane MF drivers in the M46 Main Module allows the HF exiting between the baffles to expand uninterrupted, ensuring smooth frequency response and consistent horizontal coverage.

Conventional HF diffraction using cone MF drivers.

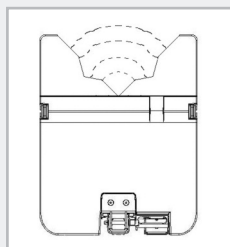

Smooth HF propagation along MF flat membrane drivers.

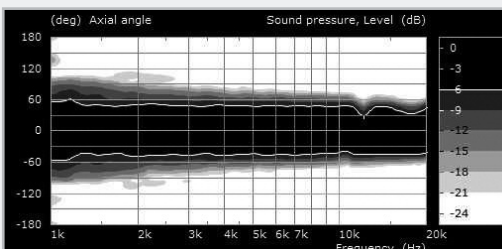
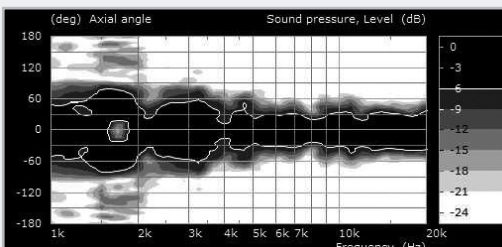
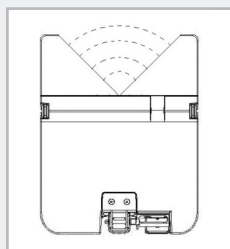

CCD patented technology for variable horizontal dispersion in the M28 Omni Module

90° horizontal dispersion

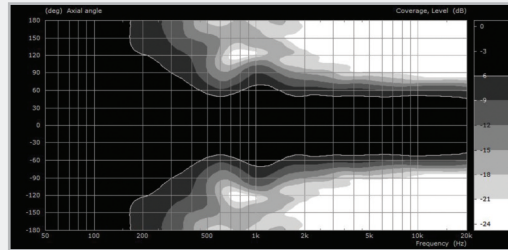
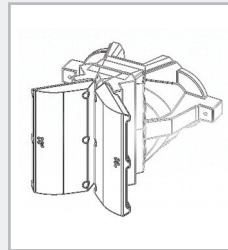

120° horizontal dispersion

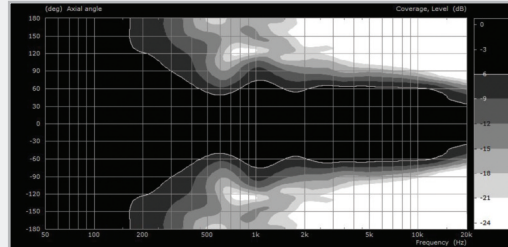
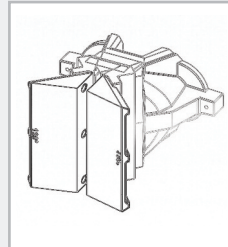

Patented vent design for improved efficiency

M28 and M46 Modules feature a patented venting design in which all radiating surfaces are in phase, improving efficiency, frequency response and coverage.

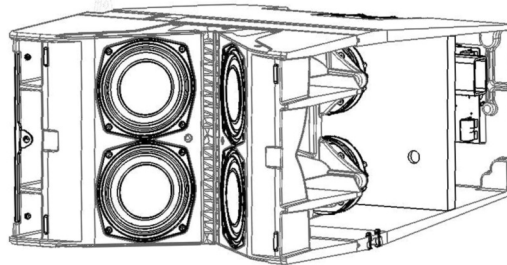

STM M46 Main Module showing patented venting design.

The effect of vent designs on MF coverage

Phase problems in conventional venting designs impair MF coverage.

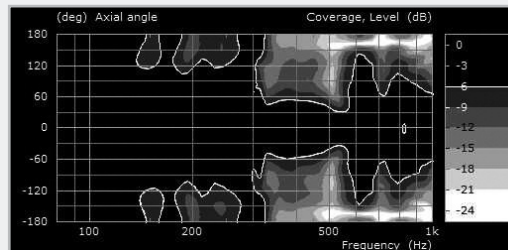
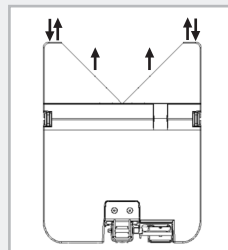

Patented STM vent design ensures all radiating surfaces are in phase, improving MF coverage.

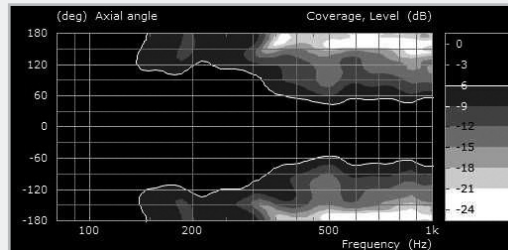
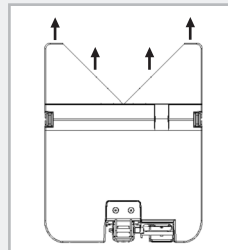

Sound science.

Increased performance through better design.

Patented 3D Hyperbolic Reflector for HF summing up to 20kHz without interference

M28 Omni and M46 Main modules employ NEXO's patented Hyperbolic Reflector. In the M46, four HRW™ waveguides are assembled into a symmetrical 90° pattern, shaping the HF wavefront such that the HF sums up to 20kHz without interference.

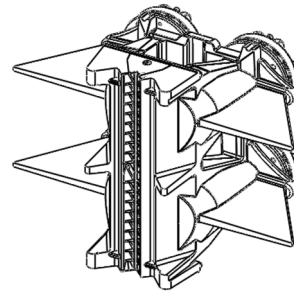

4 HRW™ waveguides assembled into a symmetrical 90° pattern in the M46.

The effect of the HRW™ waveguide on HF wave expansion

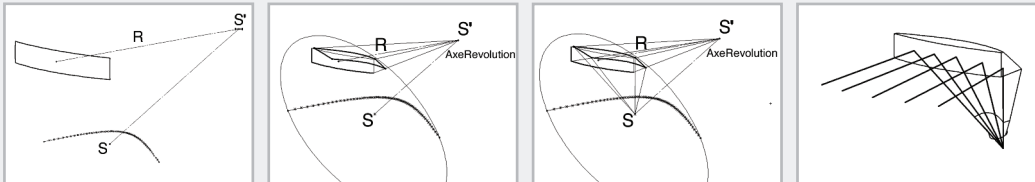

CAD construction of HRW waveguide, from desired wavefront (flat, concave or convex), to conicoid mirror definition to physical device.

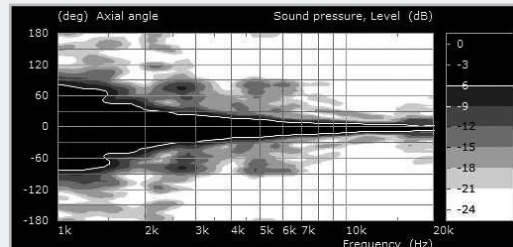

STM HF waveguide coverage versus theoretical 5° curved linear source.



S118 patented acoustic nozzle

Existing sub-bass cabinet designs use vented enclosures to increase low frequency efficiency. However the rate of airflow associated with high sound pressure levels creates turbulences (or vortexes) in conventional vent designs, impeding smooth airflow. Until now, the only solution has been to increase the cross section of the vent and, consequently, the size and volume of the cabinet. Deployed in the STM S118, NEXO replaces the vent with a patented acoustic nozzle, profiled to ensure a consistent laminar airflow through the device, minimising distortion in the low frequencies.

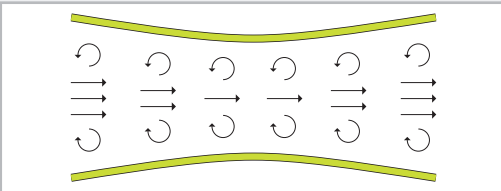

Air travelling through a conventional vent.

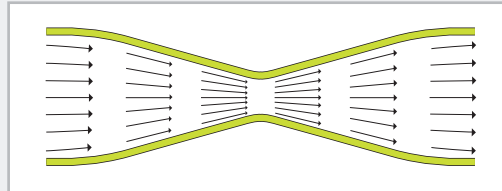

Air travelling through the S118 acoustic nozzle.

Improved control over bass frequency directivity

Compact and extremely powerful, the STM S118 sub bass module employs a single 18" driver, yet achieves performance levels similar to NEXO's acclaimed CD18 2x18" sub-bass cabinet, through innovative cabinet design.

In addition to high performance levels from a compact cabinet design, the S118 is also designed for a high level of directional control, achieved through the facility to configure cabinets in omnidirectional, cardioid side-by-side, or cardioid back-to-back modes.

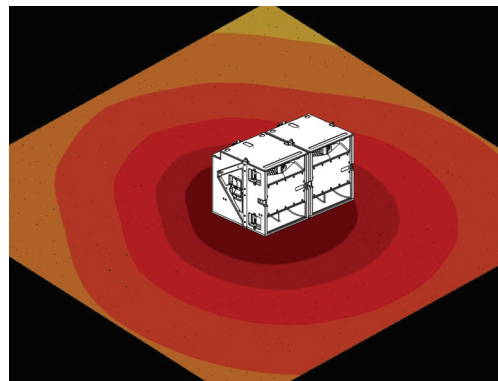

Omnidirectional configuration.

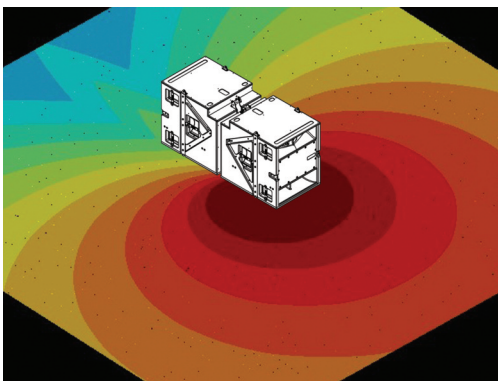

Cardioid back-to-back configuration, with maximised efficiency in VLF range.

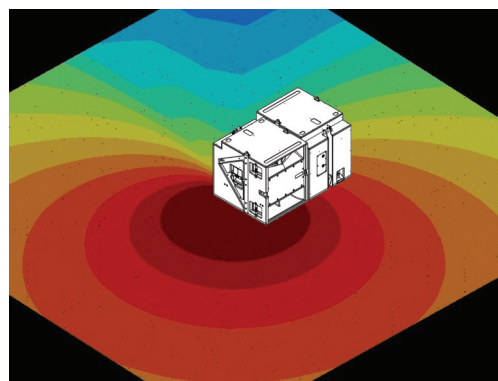

Cardioid side-by-side configuration, with a 45° outward tilted beam.







Drag and drop System configuration.

NS-1 is a powerful simulation tool that enables users to configure and optimise the performance of STM (or any other NEXO system) by predicting its behaviour in any venue.

An intuitive drag and drop interface includes all STM cabinets, with measured speaker data processed along with complex mathematical data to predict SPL and delay coverage in 3 dimensions.

Combining full acoustical and mechanical computations, NS-1 also includes tools for optimising curved vertical array design and a Help section defining mechanical constraints to establish flown system safety. NS-1 generates reports for system dimensions, weight, gravity centre position, forces, moments, working load and safety factors.

NS-1 is the essential software tool to ensure focussed, uniform SPL coverage across any given audience geometry.



ns-1





NEXO Universal Amp Rack. A scalable power solution.

The NEXO Universal Amp Rack (NUAR) provides a scalable, networkable, 'plug & play', amplified audio distribution solution, with each rack feeding 12 STM modules in any combination in groups of 3.

The NUAR rack comprises a pair of NEXO NXAMP4X4 amplifiers, twin DMU digital input metering devices, a pair of DPU digital output patching devices and a choice of 110V, 220V or dual-voltage mains distribution boxes providing power to all the components in the rack. NXAMPs can be specified with either Dante™ or EtherSound™ cards, enabling STM systems to exploit the benefits of high-performance AVB-ready digital networks.



System configuration is simple, using either ESMonitor or the new NEXO NeMo iPad® app. STM cabinet presets are selected on a channel-by-channel basis, with selected cabinet names displayed by the DPU for easy output patching.

Wheels on the NUAR are removable, and the rack can be flown using built-in hardware.



NeMo

Remote Monitoring App

Available free for iPad® and iPhone®, NEXO's NeMo Remote Monitoring app provides remote control over a NXAMP network from anywhere in the venue.

iPad® and iPhone® are registered trademarks of Apple Inc.





STM Scale Through Modularity

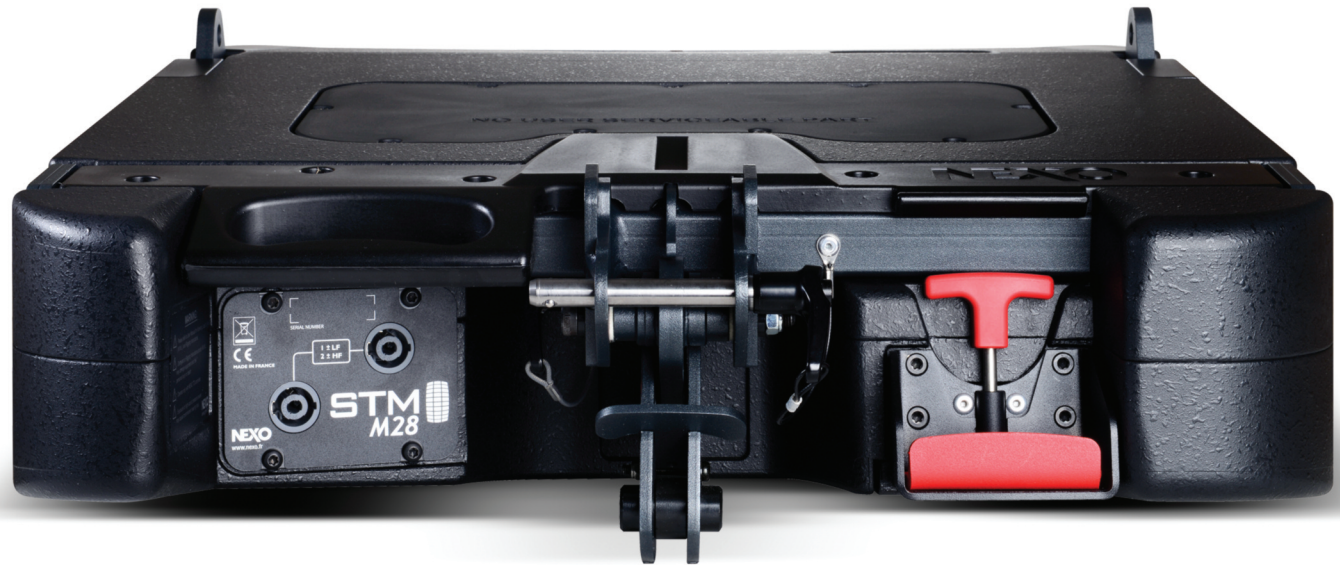



Rigging made simple. A system one man can fly.

Innovative PistonRig™, REDLock™ and CompassRig™ rigging allows the technical aspects of system rigging to be safely carried out by one person. Using a compression-mode rigging method, the system remains completely flat during rigging, and requires no lifting or pushing.

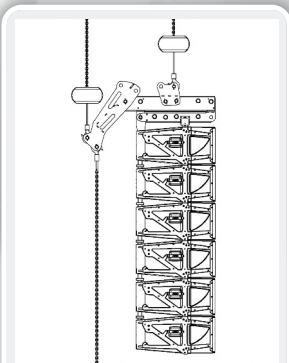

System stays flat during set up

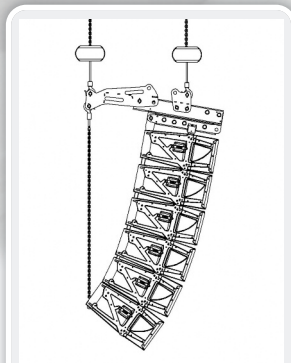

Array angles realised after lifting



VXT-LIK: Laser Inclinometer Kit

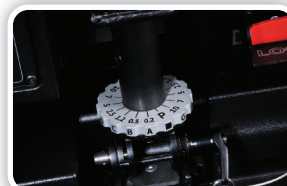
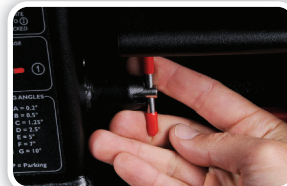
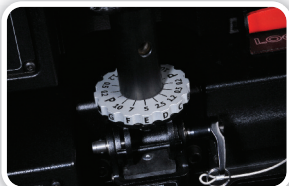

PistonRig™ allows pre-setting of inter-cabinet angle values on M46 Main and B112 Bass modules. REDLock™ handle locks front rigging points from rear of cabinet. All adjustments made from one position at rear of cluster.

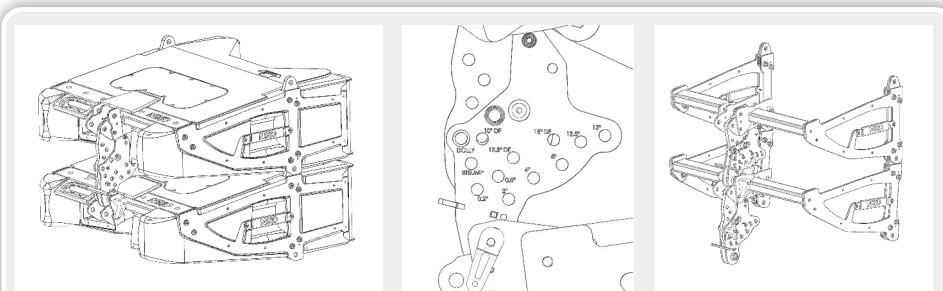

Fully compatible with the other STM modules, CompassRig™ and REDLock™ rigging enables the M28 Omni module to fly in tension mode 10°-12.5°-15° and in compression mode 0.2° to 15°.







NEXO

Designed to roll as well as it rocks.

In developing STM, NEXO considered not only the versatility and performance of the system in use, but also its efficiency of operation at every stage of the live sound rental process.

Modular dollies, road-ready casing and universal amp racks deliver significant savings in operational costs, further enhancing return on investment.

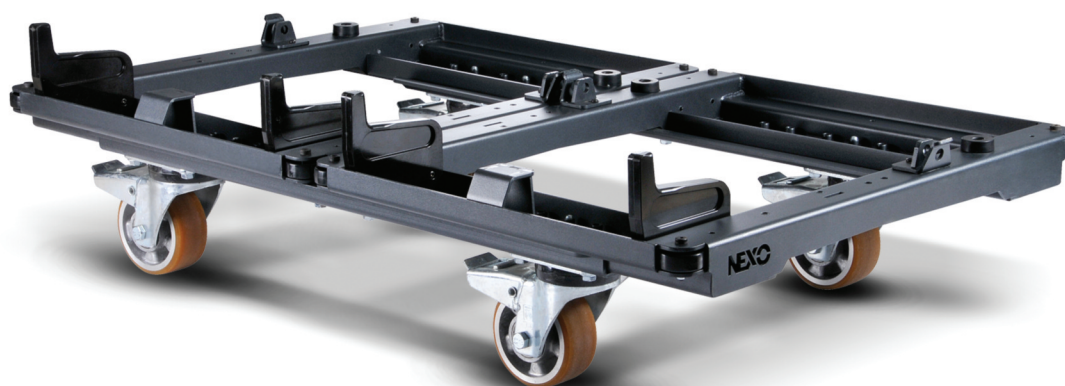



STM M28 Omni-purpose Module

Injection-moulded all-purpose loudspeaker cabinet which fulfils the role of downfill, providing 90°/120° of horizontal dispersion and 0° to 15° splaying angle between modules. Same width as M46, 2/3 height, the M28 can also be used independently from M46 or B112.

- 2 x 8 inch LF Drivers
- 2 x HF Compression Driver
- 141dB peak SPL
- Frequency response: 65Hz-19kHz
- H234mm/W575mm/D653mm
- 37Kg/82lb



Specifications

STM M28 with NXAMP 4x4	
Frequency Response [a]	65Hz – 19kHz ±3dB
Usable Range @-6dB [a]	60Hz – 20kHz
Sensitivity 1W @ 1m [b]	106dB SPL Nominal (120° horizontal coverage) 107dB SPL Nominal (90° horizontal coverage)
Nominal Peak SPL @ 1m [b]	140dB Peak (120° horizontal coverage) 141dB Peak (90° horizontal coverage)
Dispersion [c]	Configurable 90°-120° Horizontal x 0-15° vertical
Crossover Frequency	900Hz (Active)
Nominal Impedance	LF: 8 Ω (6 Ω min) - HF: 8 Ω (6 Ω min)
Amplified Controller	NXAMP4x4 - 3xSTM M28 in parallel on 2 NXAMP4x4 channels - 2x4000W/2Ω

PRODUCT FEATURES

Components :	LF: 2 x 8" (20cm) high excursion 16 Ω Neodymium drivers HF: 2 x 2.5" voice coil, 1.4" throat Neodymium 16 Ω drivers, Ketone Polymer diaphragm
Height x Width x Depth	234 x 575 x 653 mm – 9.2" x 22.6" x 25.7"
Weight : Net	37kg – 82lbs
Connectors	2 x NL4-MDV Speakon 4 poles
Construction	PU Composite Low Density – Polyurethane water based black coating
Fittings:	Handles 3 handles (2 sides and 1 rear) Front Perforated Dark Grey Metal Grille Rigging Integral 3 points flying system. Intercabinet angle adjustments from 0.2° to 15° in logarithmic steps.

SYSTEM OPERATION

Electronic Controller	The NEXO NXAMP4x4 presets are precisely matched to the STM Series cabinets and include sophisticated protection algorithms. Using STM Series cabinets without a properly connected NEXO NXAMP4x4 will result in poor sound quality and can damage components.
Sub-Bass	STM S118 extends system low frequency response down to 25Hz
Speaker Cabling	1-/1+ : LF - 2-/2+ : MF/HF

Dimensions

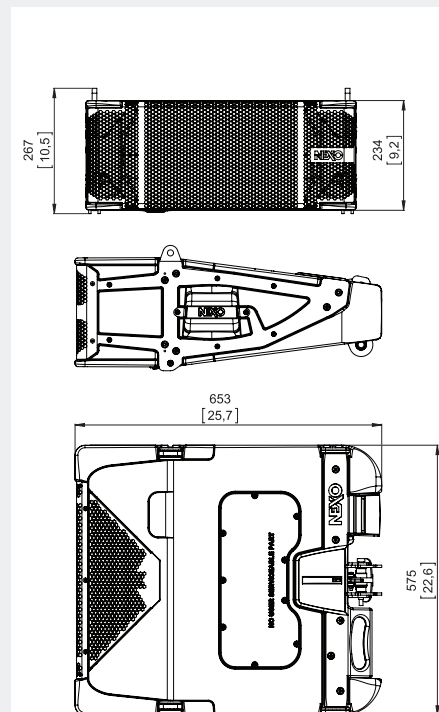

STM M46 Main Module

Injection-moulded high-power cabinet with innovative components for enhanced performance. Flat-membrane drivers ensure completely even and full-range coverage over entire 90° horizontal dispersion. HF frequency range remains completely linear, using Ketone Polymer diaphragms that enhance tonal response and long throw.

- 4 x 6.5 inch LF/MF Drivers
- 4 x HF Compression Drivers
- 145dB peak SPL
- Frequency response: 85Hz-20kHz
- H350mm/W575mm/D715mm
- 59Kg/130lb
- Dispersion 90° H x 0-10°V



Specifications

STM M46 with NXAMP 4x4

Frequency Response [a]	85Hz – 19kHz ±3dB
Usable Range @-6dB [a]	80Hz – 20kHz
Sensitivity 1W @ 1m [b]	110dB SPL Nominal
Nominal Peak SPL @ 1m [b]	145dB Peak
Dispersion [c]	90° Horizontal x 0-10° vertical
Crossover Frequency	1.5 kHz
Nominal Impedance	LF-MF:16Ω (12 Ω min) – HF: 16Ω (12 Ω min)
Amplified Controller	NXAMP4x4 - 3xSTM M46 in parallel on 2 NXAMP4x4 channels - 2x4000W/2Ω

PRODUCT FEATURES

Components :	LF-MF: 4 x 6.5" (17cm) 16 Ω flat membrane high excursion drivers. HF: 4 x 2.5" voice coil, 1.4" throat Neodymium 16 Ω drivers, Ketone Polymer diaphragm
Height x Width x Depth	350 x 575 x 715 mm – 13.78" x 22.64" x 28.15"
Weight : Net	59kg – 130lbs
Connectors	2 x NL8-MDV Speakon 8 poles (in/out) & 1 x NLT4-MDV Speakon 4 poles (to STM S118 and B112)
Construction	PU Composite Low Density – Polyurethane water based black coating
Fittings:	Handles 3 handles (2 sides and 1 rear)
	Front Perforated Dark Grey Metal Grille
	Rigging Integral 3 points flying system. Intercabinet angle adjustments from 0.2° to 10° in logarithmic steps.

SYSTEM OPERATION

Electronic Controller	The NEXO NXAMP4x4 presets are precisely matched to the STM Series cabinets and include sophisticated protection algorithms. Using STM Series cabinets without a properly connected NEXO NXAMP4x4 will result in poor sound quality and can damage components.
Sub-Bass	STM S118 extends system low frequency response down to 25Hz
Speaker Cabling	1-/1+: SUB - 2-/2+: LF - 3-/3+: LF-MF 4-/4+: HF

Dimensions

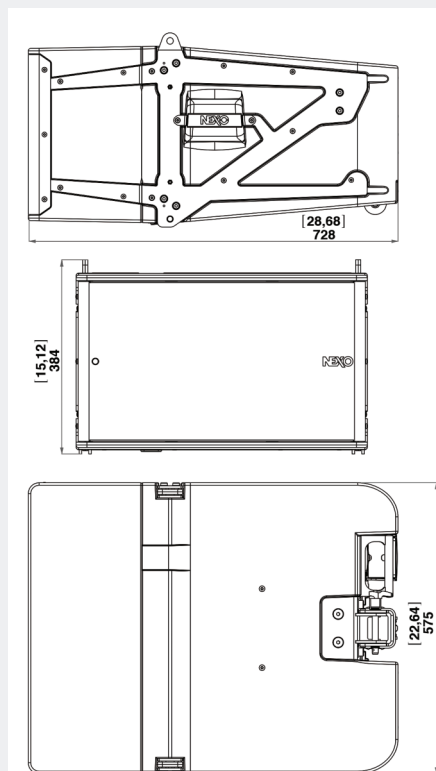



STM B112 Bass Module

Injection-moulded bass cabinet featuring a Neodymium high excursion 3000W 12" bass driver with 4" voice coil. It has the same format – dimensions, weight, gravity centre – as the M46. The hybrid horn-loaded design maximizes the efficiency of the driver, delivering 6dB more than a standard front-loaded driver in this frequency range.

- 1 x 3000W +/- 3cm excursion 12 inch LF Driver
- 141dB peak SPL
- Frequency response: 63Hz-200Hz
- H350mm/W575mm/D715mm
- 59Kg/130lb



Specifications

STM B112 with NXAMP 4x4

Frequency Response [a]	63Hz – 200Hz ±3dB
Usable Range @-6dB [a]	55Hz – 250Hz
Sensitivity 1W @ 1m [b]	107dB SPL Nominal
Nominal Peak SPL @ 1m [b]	141dB Peak
Nominal Impedance	16Ω (12 Ω min)
Amplified Controller	NXAMP4x4 - 3xSTM B112 in parallel on 2 NXAMP4x4 bridged channels - 8000W/4Ω

PRODUCT FEATURES

Components :	LF: 1 x 12" (30cm) 3000W high excursion Neodymium 16 Ohms driver.
Height x Width x Depth	350 x 575 x 715 mm – 13.78" x 22.64" x 28.15"
Weight : Net	59kg – 130lbs
Connectors	2 x NLT4-MDV Speakon 4 poles (in/out)
Construction	PU Composite Low Density – Polyurethane water based black coating
Fittings:	Handles 3 handles (2 sides and 1 rear)
	Front Perforated Dark Grey Metal Grille
	Rigging Integral 3 points flying system. Intercabinet angle adjustments from 0.2° to 10° in logarithmic steps.

SYSTEM OPERATION

Electronic Controller	The NEXO NXAMP4x4 presets are precisely matched to the STM Series cabinets and include sophisticated protection algorithms. Using STM Series cabinets without a properly connected NEXO NXAMP4x4 will result in poor sound quality and can damage components.
Sub-Bass	STM S118 extends system low frequency response down to 25Hz
Speaker Cabling	1-/1+ : SUB - 2-/2+ : LF

As part of a policy of continual improvement, NEXO reserves the right to change specifications without notice.
 [a] Response curves & data : Half-Space Far Field for the STM S118 & B112 + NXAMP4x4.
 [b] Sensitivity & Peak SPL data : these will depend on spectral distribution and crest factor of program material. Measured with band limited Pink Noise. Data are for speaker + amplified controller. Peak SPL is at clipping of NXAMP4x4.
 [c] Directivity curves & data : obtained by computer treatment on off axis response curves.

Dimensions

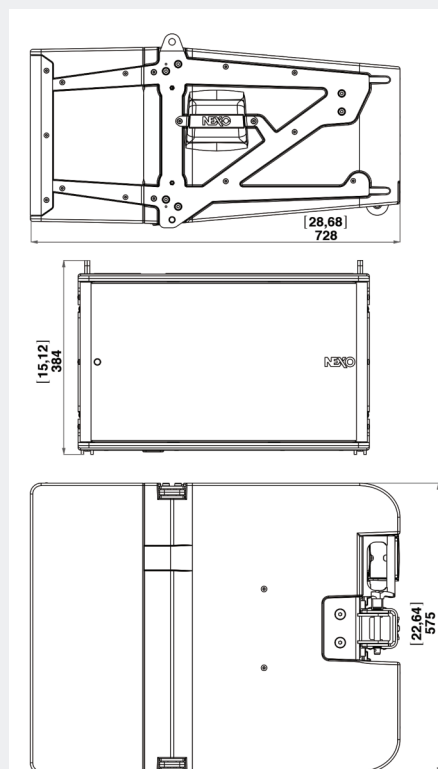

STM S118 Sub Module

Sub-bass cabinet featuring a Neodymium high excursion 3000W 18" driver. A bandpass load ensures SPL output equivalent to conventional dual 18" sub-basses. Same width, double the height of M46 main cabinet, double height of main cabinet so the S118 can be flown in the array or ground-stacked in line. Can be run in omnidirectional or cardioid sub mode.

- 1 x 18 inch LF Driver
- 143dB peak SPL
- Frequency response: 25Hz-85Hz
- H700mm/W575mm/D715mm
- 85Kg/187lb
- Omni or cardioid modes



Specifications

STM S118 with NXAMP 4x4

Frequency Response [a]	27Hz – 85Hz ±3dB
Usable Range @-6dB [a]	23Hz – 100Hz
Sensitivity 1W @ 1m [b]	109dB SPL Nominal
Nominal Peak SPL @ 1m [b]	143dB Peak
Nominal Impedance	16Ω (12 Ω min)
Amplified Controller	NXAMP4x4 - 3xSTM S118 in parallel on 2 NXAMP4x4 bridged channels - 8000W/4Ω

PRODUCT FEATURES

Components :	LF: 1 x 18" (46cm) 3000W high excursion Neodymium 16 Ohms driver.
Height x Width x Depth	700 x 575 x 715 mm – 27.56" x 22.64" x 28.15"
Weight : Net	85kg – 187lbs
Connectors	2 x NLT4-MDV Speakon 4 poles (in/out)
Construction	Baltic birch ply finished with structured black coating
Fittings:	Handles 6 handles (3 per side)
	Front Perforated Dark Grey Metal Grille
	Rigging Integral 3 points flying and locking system.

SYSTEM OPERATION

Electronic Controller The NEXO NXAMP4x4 presets are precisely matched to the STM Series cabinets and include sophisticated protection algorithms. Using STM Series cabinets without a properly connected NEXO NXAMP4x4 will result in poor sound quality and can damage components.

Speaker Cabling 1-/1+ : SUB - 2-/2+ : LF

Dimensions (outermost)

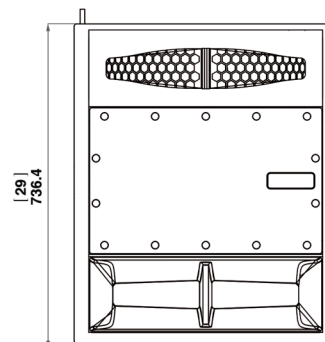
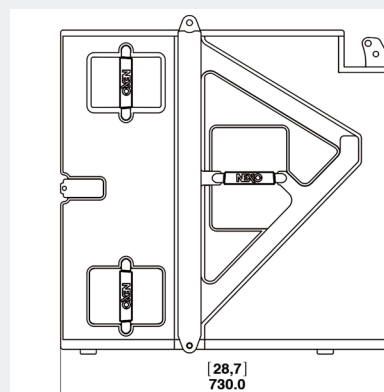

As part of a policy of continual improvement, NEXO reserves the right to change specifications without notice.
 [a] Response curves & data : Half-Space Far Field for the STM S118 & B112 + NXAMP4x4.
 [b] Sensitivity & Peak SPL data : these will depend on spectral distribution and crest factor of program material. Measured with band limited Pink Noise. Data are for speaker + amplified controller. Peak SPL is at clipping of NXAMP4x4.
 [c] Directivity curves & data : obtained by computer treatment on off axis response curves.



Hardware and Accessories

The STM philosophy of scale through modularity extends to a comprehensive range of rigging hardware and accessories, designed and engineered to set new standards of efficiency for transporting and flying a sound system.

Available online at the NEXO website, the STMCalc web app makes it easy to calculate the precise inventory of accessories necessary for any scale of STM system.



STT-LBUMPER Lightweight '2-Wide' Bumper



STT-BTBUMPER: Bottom Bumper



STT-BCOUP2: 2 Bottom Bumper Coupling Device



STT-BCOUP3: 3 Bottom Bumper Coupling Device



STT-XBOW: Crossbow

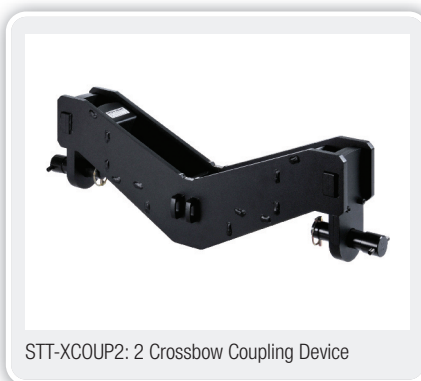

STT-XCOUP2: 2 Crossbow Coupling Device



STT-XCOUP3: 3 Crossbow Device



STT-MBEAM: Crossbow Main Beam



STT-KBEAM: Kelping Beam



STT-PTILT: Front Linking Device





STT-MLINK: Chain Motor Linking Device



STT-DPLATE: Delta Plate

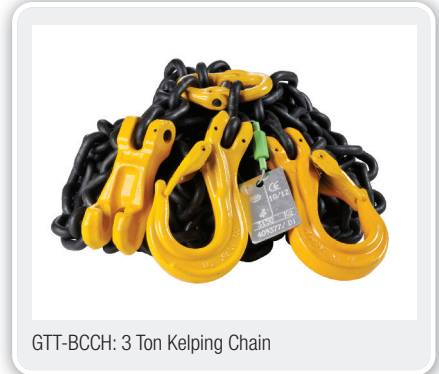

GTT-BCCH: 3 Ton Kelping Chain

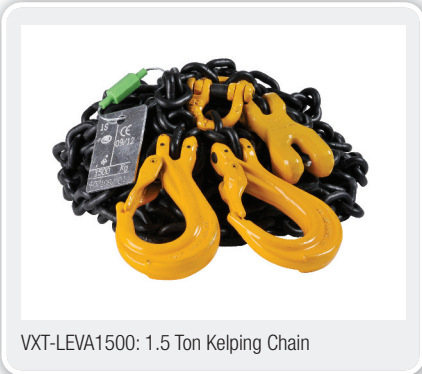

VXT-LEVA1500: 1.5 Ton Kelping Chain



STT-DOLLY01/02: Single/Double Dollies



STT-DOLLY28 Lightweight M28 Dolly



SST-DRROOF: Roof for STM Dolly M46/B112



STT-DCOVER01/02: Single/Double Dolly Covers

E & OE December 2012. NEXO reserves the right to change specifications without notice.





NEXO S. A.

Parc D'Activité
du Pré de la Dame Jeanne
B.P.5
60128 PLAILLY
France
Tel: +33 (0)3 44 99 00 70
Fax: +33 (0)3 44 99 00 30
E-mail: info@nexo.fr

NEXO LatAm

Tel: +1 305 677 9322
Fax: +1 360 234 7870
Email: info@nexo.fr

NEXO Asia

GPO Box 806
Hong Kong
SAR China
Tel: +852 9096 3472
Fax: +852 2104 3214
E-mail: info@nexo.fr

www.nexo.fr

NEXO

