

### Flange 120° M28

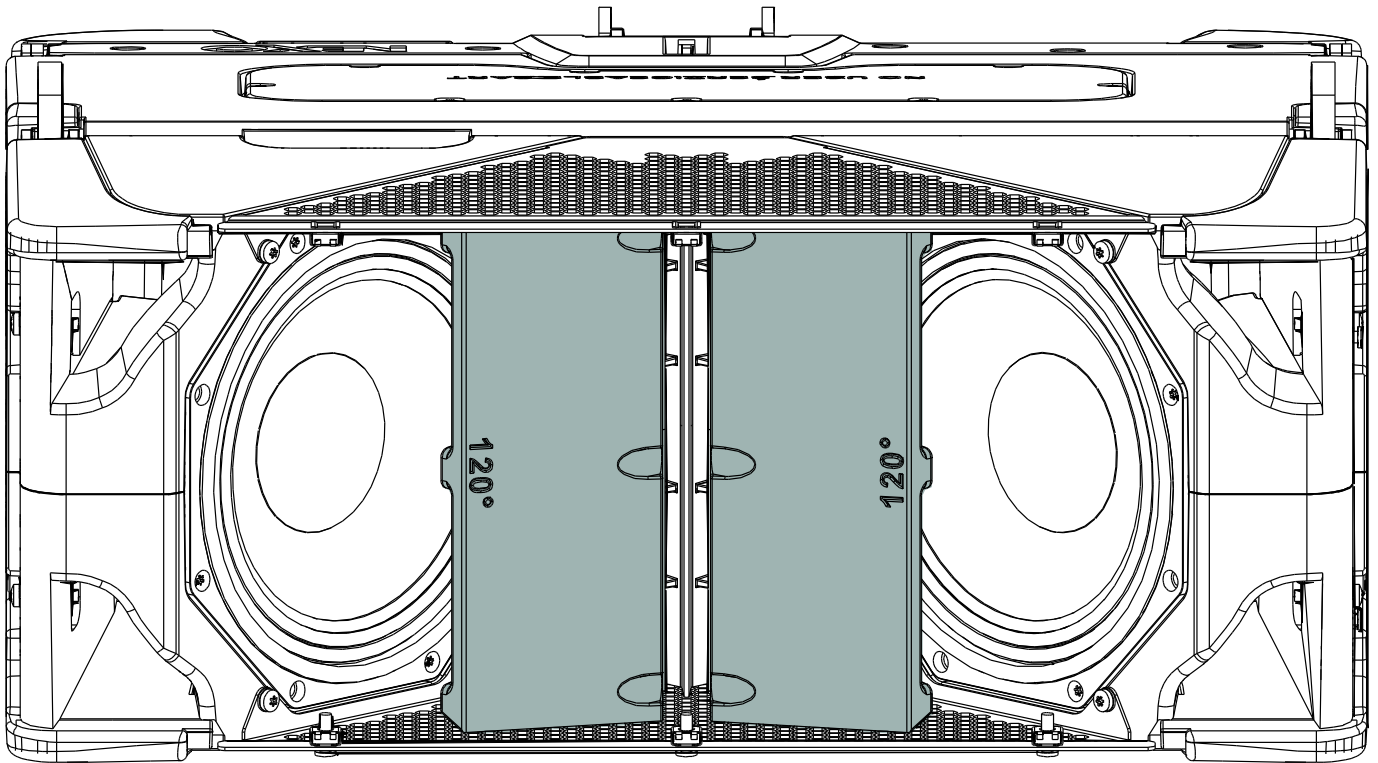

### Contents:

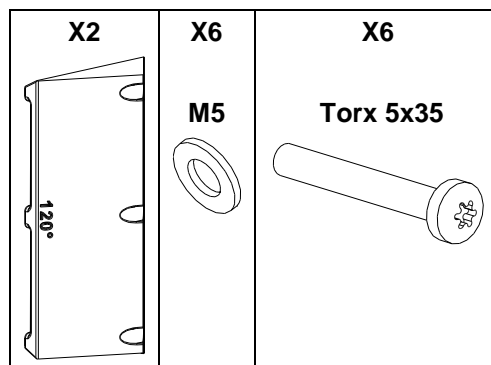

Weight: 1.2 kg / 2.7 lb

## Assembly

Remove the 8 screws and the front grid

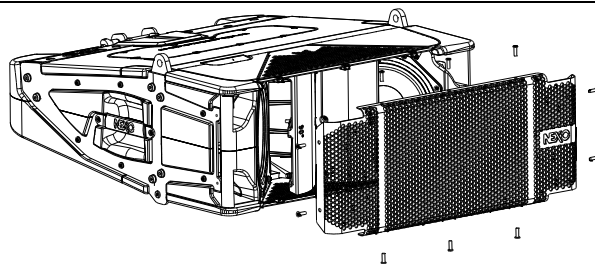

Unscrew the 3 screws and remove the first FLG28090, unscrew 3 screws and remove the second.

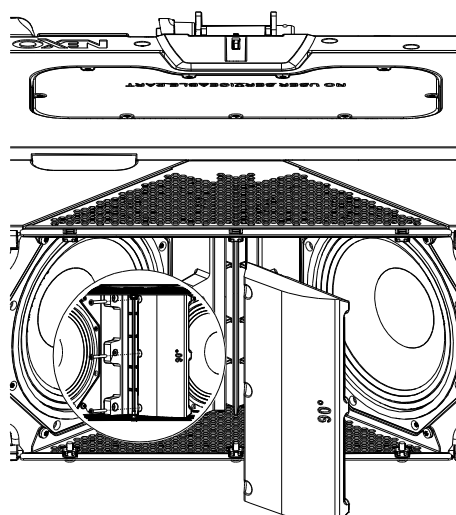
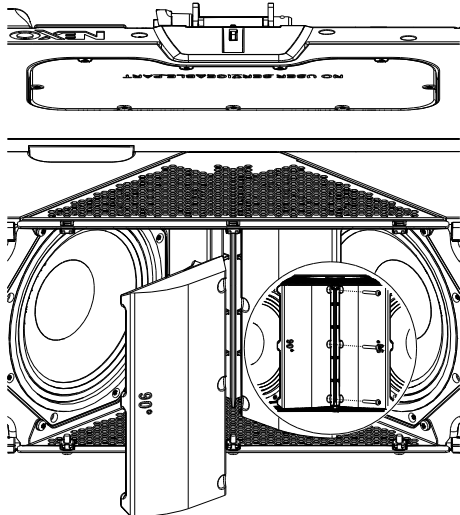

Position the first FLG28120 with 3 screws, position the second with 3 screws. (Use provided screws)

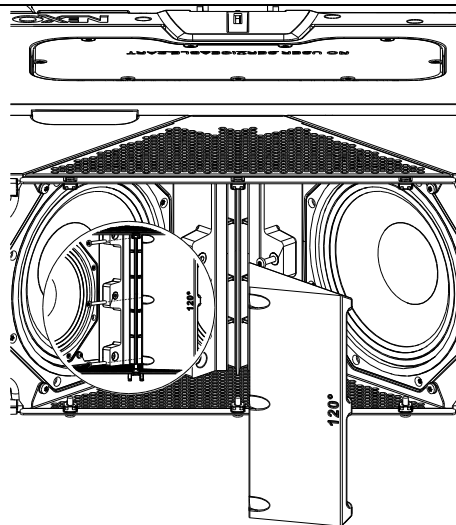
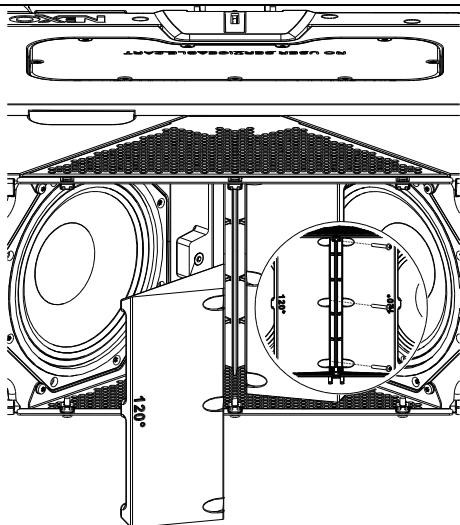

- NEXO cannot accept responsibility for accidents caused by any factor other than defects in this product itself.
- Please check the web site [nexo-sa.com](http://nexo-sa.com) for the latest update.

# NEXO

nexo-sa.com

ZA du Pre de la Dame Jeanne  
60128 PLAILLY - France

- Read this document before using.
- Keep this document.
- Observe all warnings and cautions.