

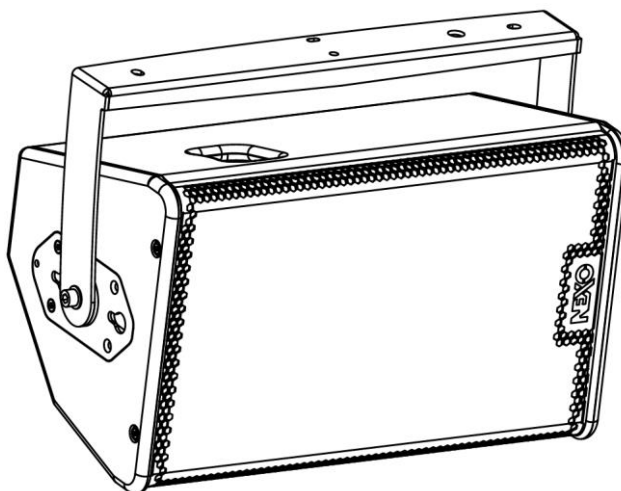

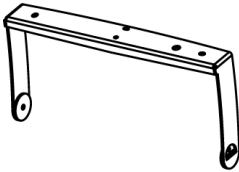







Lyre d'accrochage pour PS10

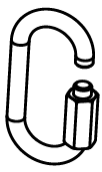

Contenu :

X1 	X1 	X1 <u>M10</u> 	X1 <u>M6</u> 	X1 <u>M6x20</u> 	X1 <u>M10x20</u> 
---	---	---	---	---	--

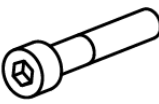
 Les pièces ci-dessous sont utilisées pour le montage avec la potence murale NEXO : VNI-WS10.



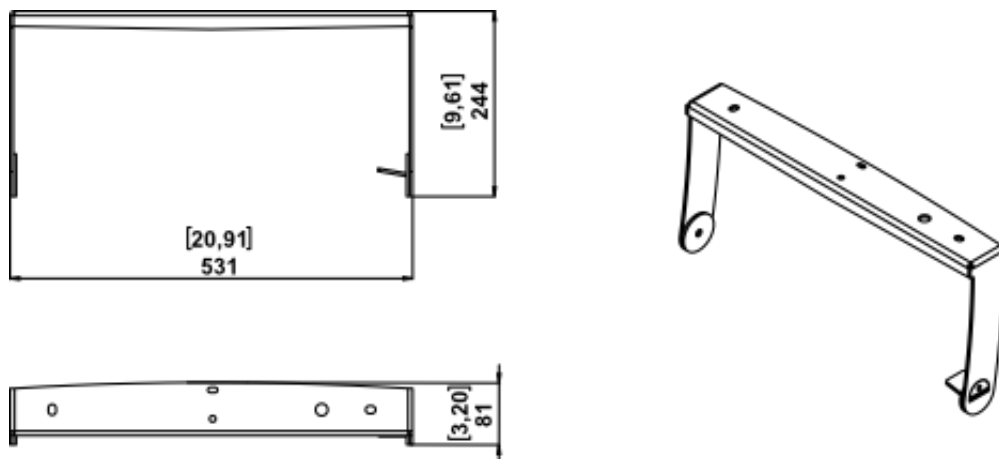

X1 	X1 	X1 <u>M8x45</u> 	X1 <u>M8</u> 	X1 <u>M8</u> 
---	---	--	--	--

Poids : 2.5 kg / 5.5 lb

Dimensions :



Assemblage sur une enceinte :

X1	X1	X1	X1	X1
	<u>M10</u> 	<u>M6</u> 	<u>M6x20</u> 	<u>M10x20</u> 



ATTENTION : Les vis doivent être encollées avec de la Loctite 243 TM

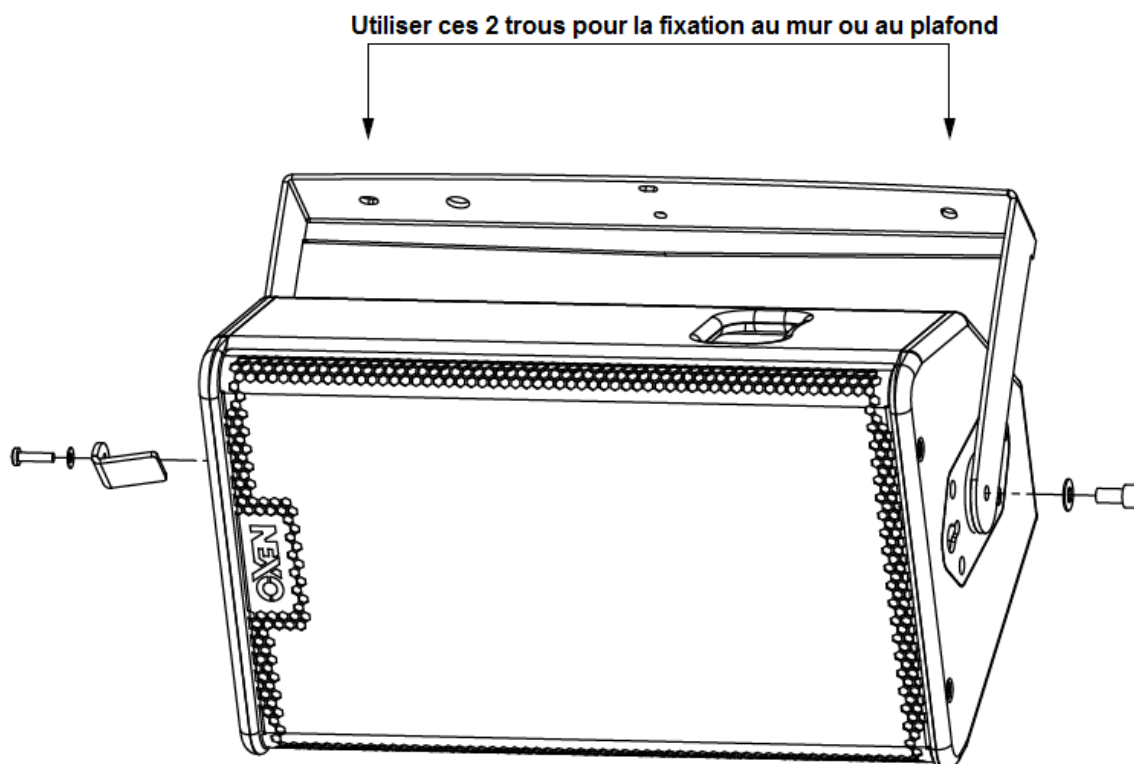

Assemblage avec VNI-WS10



NEXO

nexo-sa.com
ZA du Pre de la Dame Jeanne
60128 PLAILLY - France

- Lire cette fiche avant utilisation.
- Conserver cette fiche.
- Respecter les avertissements.



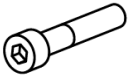

Utiliser uniquement la visserie fournie avec le VNI-UBRK10 (voir ci-dessous), et la rondelle M8 du VNI-WS10.

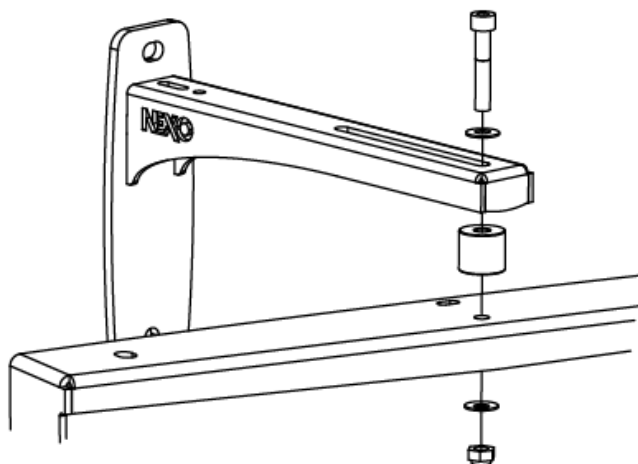
X1	X1	<u>M8x45</u>	X1	<u>M8</u>	X2	<u>M8</u>
						



Montage de l'élingue de sécurité

X1	X2 (le second anneau rapide est fourni avec le VNI-WS10).
	

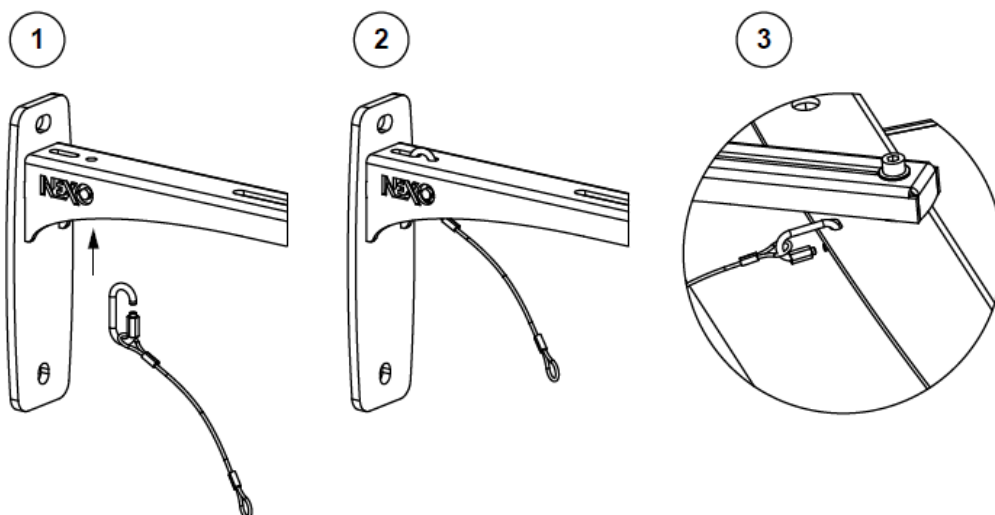

- NEXO ne peut pas accepter la responsabilité d'accidents causés par un facteur autre qu'un défaut de ce produit.

NEXO

nexo-sa.com

ZA du Pre de la Dame Jeanne
60128 PLAILLY - France

- Lire cette fiche avant utilisation.
- Conserver cette fiche.
- Respecter les avertissements.

